

BJP 38 202

TECHNICAL SHEET

AIR NOZZLES

FLAT AIRSTREAM



OPERATING PRINCIPAL

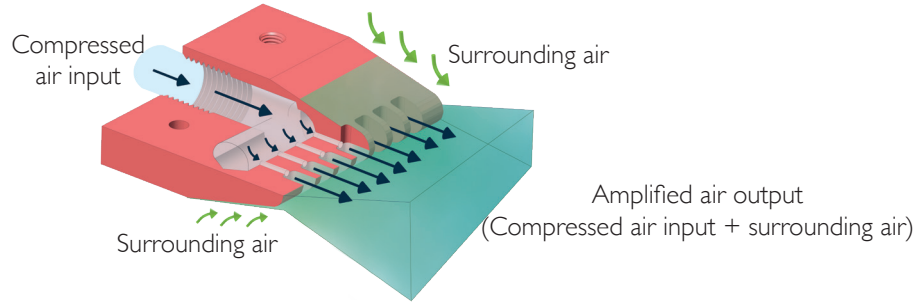

Booster
RATIO
UP TO
25/1

TECHNICAL INFORMATION*

BENEFITS OF USING A BJP 38 202 AIR NOZZLE* (Compared to an open pipe)		Increase of blowing force (%)		Noise reduction (%)		
		Up to 74%		Up to 35%		
BLOWING PERFORMANCE BJP 38 202 NOZZLE*	Pressure (bar)	Air consumption (l/min)	Blowing force (N)		Noise level (dB)	Amplified blowing (l/min)
	6	2240	at 150mm 34	at 450mm 32,4	72	6600
VS OPEN PIPE Ø12*	Pressure (bar)	Air consumption (l/min)		Noise level (dB)	Amplified blowing (l/min)	
	6	4450		110	4450	

BJP 38 202 NOZZLE FEATURES

- **Connection** : Female G3/8" • **Weight** : Aluminium : 383g / Stainless steel 316 : 1098g
- **Max. operating temperature** : Aluminium : 150°C / Stainless steel 316 : 450°C • **Max pressure** : 10 bars

**AIR CONSUMPTION
DEPENDING ON PRESSURE***

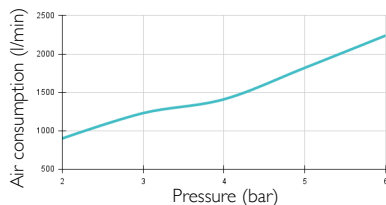

**BLOWING FORCE AT 150 MM
DEPENDING ON PRESSURE***

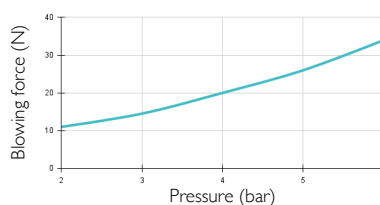

**BLOWING FORCE AT 450 MM
DEPENDING ON PRESSURE***

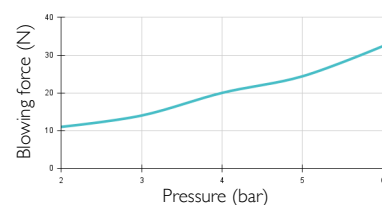

**AMPLIFIED BLOWING
DEPENDING ON PRESSURE***

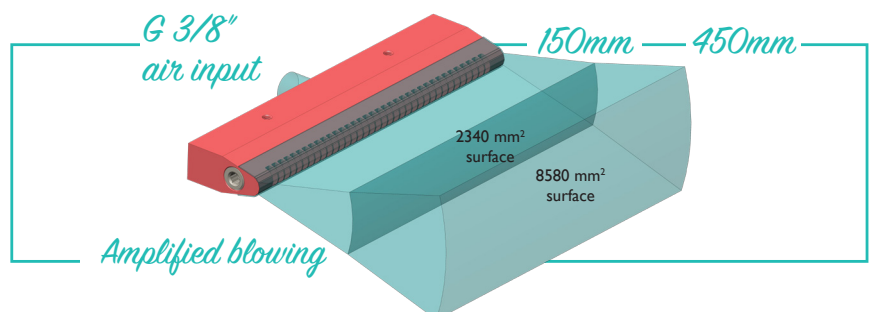
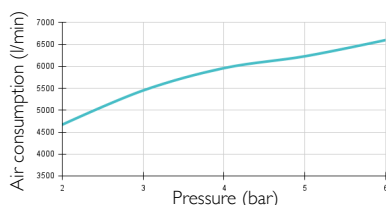

* **NOTE:** The measurements in this data sheet have been obtained in a laboratory **under strict control**. The varying conditions of a real industrial environment and the instability of pressure from an industrial compressor can create different values than the ones obtained in a laboratory. These data are provided for information purposes only.
To achieve the best performance from the air nozzle, we recommend using a compressed air supply tube with a minimum 12 mm inside diameter.

DIMENSIONS

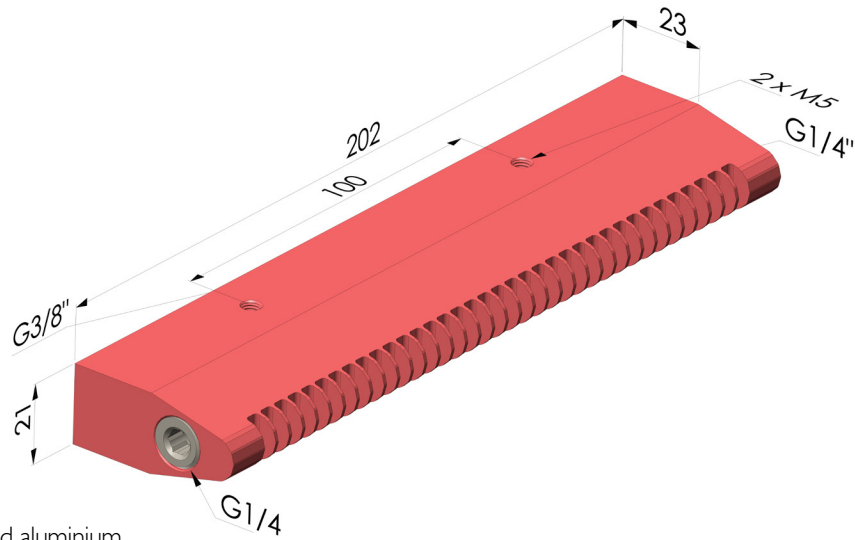

BJP 38 202 ■ Anodized aluminium

BJP 38 202 ACI ■ 316L Stainless steel

The values are given in millimeters