

RA-3 150

TECHNICAL SHEET

AIR KNIVES

SINGLE FLOW



OPERATING PRINCIPAL

Economical

UP TO **92%** SAVINGS IN AIR CONSUMPTION

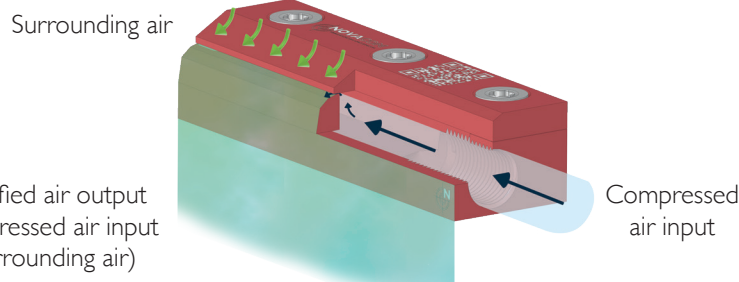

TECHNICAL INFORMATION*

BENEFITS OF USING THE RA-3 150 AIR KNIFE* (Compared to an open pipe)		Reduction in air consumption (%)		Noise reduction (%)		
		Up to 92%		Up to 39%		
PERFORMANCES AIR KNIFE RA-3 150*	Pressure (bar)	Air consumption (l/min)	Blowing force (N)		Noise level (dB)	Amplified air (l/min)
	2	450	at 150mm	at 450mm	79	9000
	6	1150	8	7.3	90	23000
VS OPEN PIPE Ø8* (opened on 150mm)		Pressure (bar)	Air consumption (l/min)	Noise level (dB)	Amplified air (l/min)	
		6	5700	130	5700	

RA-3 150 AIR KNIFE FEATURES

- **Connection** : Female G1/4"
- **Weight** : Aluminium : 241g / Stainless steel 316 L : 709g
- **Max. operating temperature** : Aluminium : 150°C / Stainless steel 316 L : 450°C
- **Max pressure** : 10 bars

AMPLIFIED AIRSTREAM
DEPENDING ON PRESSURE*

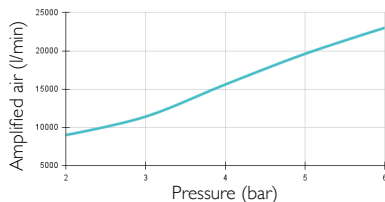

BLOWING FORCE AT 150 MM
DEPENDING ON PRESSURE*

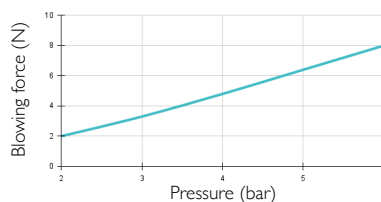

BLOWING FORCE AT 450 MM
DEPENDING ON PRESSURE*

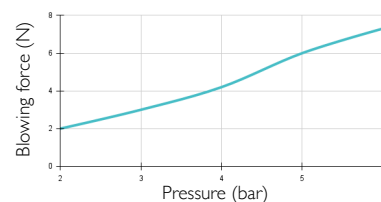

AIR CONSUMPTION
DEPENDING ON PRESSURE*

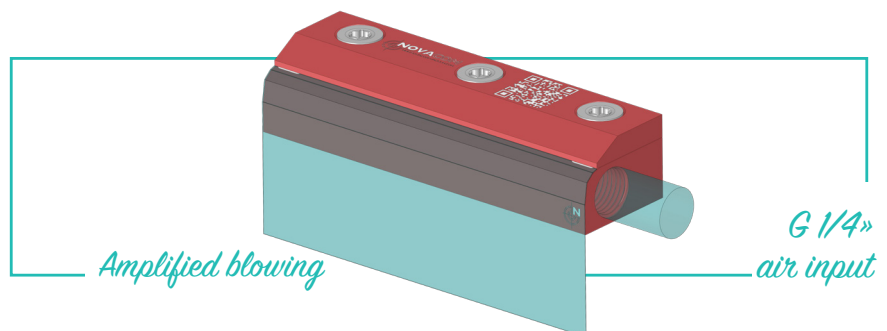
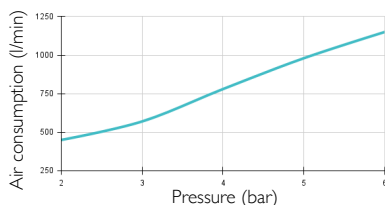

* **NOTE:** The measurements in this data sheet have been obtained in a laboratory under strict control. The varying conditions of a real industrial environment and the instability of pressure from an industrial compressor can create different values than the ones obtained in a laboratory. Those data are provided for information purposes only. To achieve the best performance from the air knives, we recommend using a compressed air supply tube with a minimum 8 mm inside.

DIMENSIONS

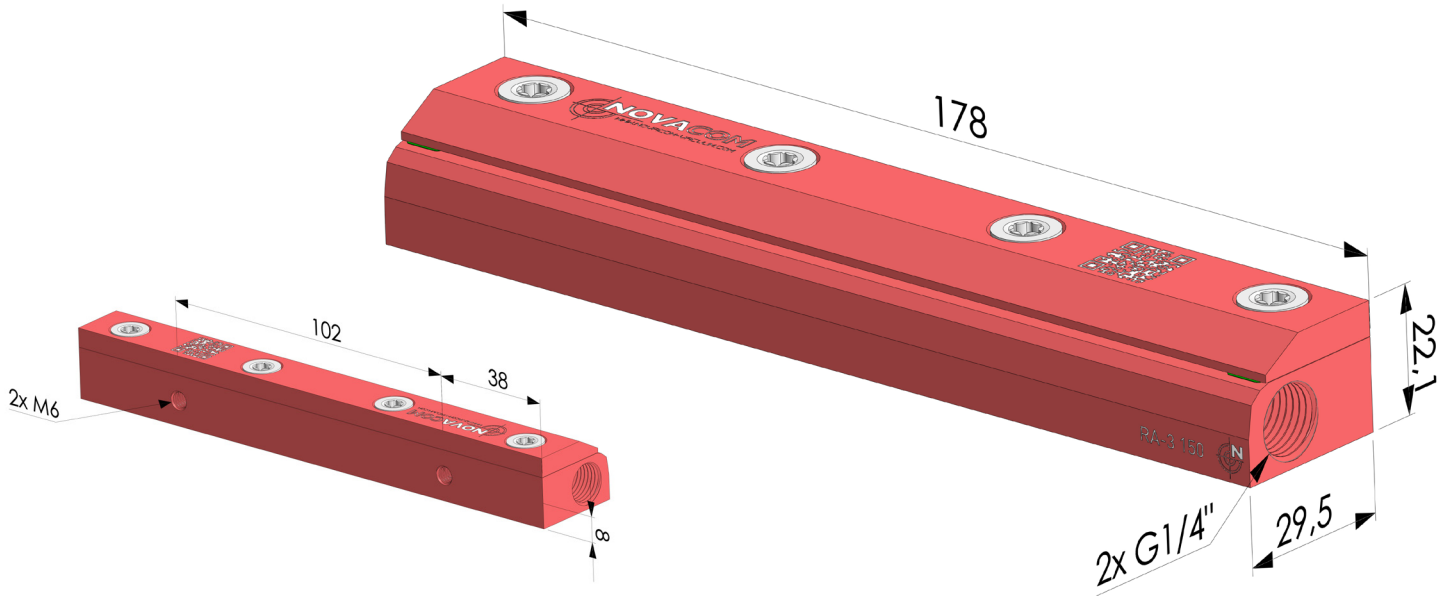

RA-3 150 ■ Anodized aluminium

RA-3 150 ACI ■ 316L Stainless steel

The values are given in millimeters