

TECHNICAL INFORMATION

- Range :** Suction cup
Category : Plates
Series : VPC
Height (in mm) : 12.1
Shape : Plate
Contact lip diameter : 25 mm
inner barrel diameter : 3.8 mm
Number of bellows : 0.5 Bellows
Horizontal force : 20.56 N
Vertical force : 10.28 N
Volume : 0.75 cm³
Mass : 1.40 g
Arrow : 3 mm

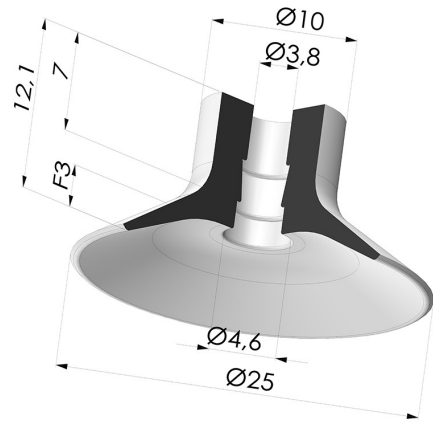

Variants:



- Variant reference:
VPC 25SLT A
- Color: Translucent
 - CE food certified
 - Matter: Silicone
 - Shore Hardness: SH60





- Variant reference:
VPC 25MNT A
- Color: Bordeaux
 - Matter: Non-staining material for plastics processing
 - Shore Hardness: SH60



- Variant reference:
VPC 25NI A
- Color: Black
 - Matter: Nitrile
 - Shore Hardness: SH50

Material guide:

	Material	Code	Temperature resistance (°C)	Flexibility	Abrasion resistance	UV/Weather resistance	Oil resistance	Food compatibility	Migration test
	Silicone Translucent (Shore SH60)	SL T	-60/+250	✓✓✓	✓	✓✓✓	✓	FDA  **	✗
	Nitrile Black (Shore SH50)	NI	-10/+80	✓	✓	✗	✓✓	✗	✗

Requests for FDA and/or EC certificates must be made AT THE TIME OF ORDER. Any later request will incur additional charges. To meet the expectations of our industrial customers, NOVACOM offers the widest range of elastomer and thermoplastic materials. We can also develop new materials based on precise specifications, in order to solve specific applications for our customers.

 Excellent |
  Good |
  Low |
  Poor |
  Not recommended
 *FDA and/or EC certificate may be requested for various references at the time of order; please contact us.
 ** Food contact certification: (EC) 1935/2004 - (FDA) 21 CFR 177.2600
 *** Food contact certification: (EC) 10/2011 - (FDA) 21 CFR

Related products:

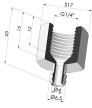

Separable Female Fitting G1/4"

Product reference: B

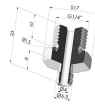

Separable Male Fitting G1/4"

Product reference: C

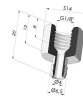

Separable Female Fitting G1/8"

Product reference: F



Adaptor - Female G1/4" - Female G1/8"

Product reference: 301
048



Adaptor - Female 1/8G - Female M6

Product reference: F18F6



Separable Male Fitting 1/8G

Product reference: FTM
20 G1/8 PO



Separable Male Fitting G1/8"

Product reference: G



Adaptor - Male 1/4G - Female 1/8G

Product reference: 209
048



Adaptor - Male 1/8G - Female M6

Product reference: M18F6



Separable Male Fitting M6

Product reference: M6C