

**TECHNICAL INFORMATION**

- Range :** Suction cup  
**Category :** Plates  
**Series :** 7SB  
**Height (in mm) :** 29  
**Shape :** Plate  
**Contact lip diameter :** 101.5 mm  
**inner barrel diameter :** Male G3/8"  
**Number of bellows :** 0.5 Bellows  
**Horizontal force :** 363 N  
**Vertical force :** 181.5 N  
**Arrow :** 4 mm

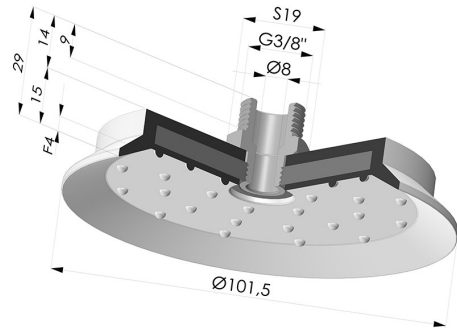

**Variants:**



Variant reference:  
**7SB 100SLT M38**

- Color: Translucent
- CE food certified
- Matter: Silicone
- Shore Hardness: SH60



Variant reference:  
**7SB 100NI M38**

- Color: Black
- Matter: Nitrile
- Shore Hardness: SH50

**Material guide:**

	Material	Code	Temperature resistance (°C)	Flexibility	Abrasion resistance	UV/Weather resistance	Oil resistance	Food compatibility	Migration test
	Silicone Translucent (Shore SH60)	SL T	-60/+250	✓✓✓	✓	✓✓✓	✓	FDA  **	✗
	Nitrile Black (Shore SH50)	NI	-10/+80	✓	✓	✗	✓✓	✗	✗

Requests for FDA and/or EC certificates must be made AT THE TIME OF ORDER. Any later request will incur additional charges. To meet the expectations of our industrial customers, NOVACOM offers the widest range of elastomer and thermoplastic materials. We can also develop new materials based on precise specifications, in order to solve specific applications for our customers.

Excellent | Good | Low | Poor | Not recommended  
 \*FDA and/or EC certificate may be requested for various references at the time of order; please contact us.  
 \*\* Food contact certification: (EC) 1935/2004 - (FDA) 21 CFR 177.2600  
 \*\*\* Food contact certification: (EC) 10/2011 - (FDA) 21 CFR