

TECHNICAL INFORMATION

Range :	Suction cup
Category :	With bellows
Series :	8SB
Height (in mm) :	44
Shape :	1.5 Bellows
Contact lip diameter :	75 mm
inner barrel diameter :	Male G1/4"
Number of bellows :	1.5 Bellows
Horizontal force :	200 N
Vertical force :	100 N
Arrow :	16 mm

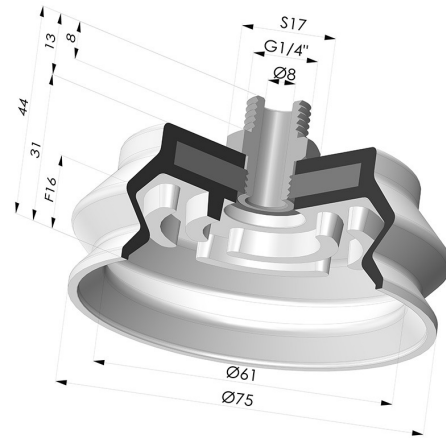

Variants:



Variant reference:
8SB 75SLT M14

- Color: Translucent
- CE food certified
- Matter: Silicone
- Shore Hardness: SH60



Variant reference:
8SB 75NI M14

- Color: Black
- Matter: Nitrile
- Shore Hardness: SH50