

**TECHNICAL INFORMATION**

- Range :** Suction cup
- Category :** With bellows
- Series :** 8SB SPF
- Height (in mm) :** 31
- Shape :** 1.5 Bellows
- Contact lip diameter :** 75 mm
- inner barrel diameter :** 14mm
- Number of bellows :** 1.5 Bellows
- Horizontal force :** 180 N
- Vertical force :** 90 N
- Arrow :** 16 mm

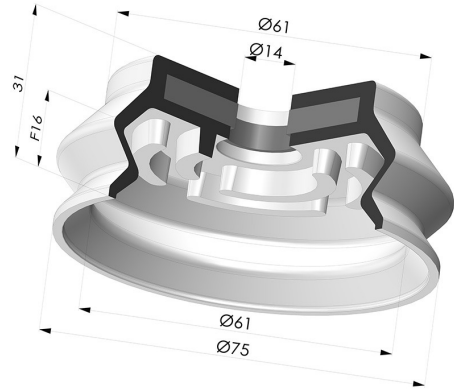



**Variants:**



Variant reference:  
**8SB 75SLB SPF14**

- Color: Blue food-grade CE certification
- Matter: Silicone
- Shore Hardness: SH60

**Material guide:**

	Material	Code	Temperature resistance (°C)	Flexibility	Abrasion resistance	UV/Weather resistance	Oil resistance	Food compatibility	Migration test
	Silicone Blue food-grade CE certification (Shore SH60)	SLBLEU	-60/+250	✓✓✓	✗	✓✓✓	✗	FDA  **	A, B, D2

Requests for FDA and/or EC certificates must be made AT THE TIME OF ORDER. Any later request will incur additional charges. To meet the expectations of our industrial customers, NOVACOM offers the widest range of elastomer and thermoplastic materials. We can also develop new materials based on precise specifications, in order to solve specific applications for our customers.

 Excellent | 
  Good | 
  Low | 
  Poor | 
  Not recommended  
 \*FDA and/or EC certificate may be requested for various references at the time of order; please contact us.  
 \*\* Food contact certification: (EC) 1935/2004 - (FDA) 21 CFR 177.2600  
 \*\*\* Food contact certification: (EC) 10/2011 - (FDA) 21 CFR