

TECHNICAL INFORMATION

Range :	Suction cup
Category :	With bellows
Series :	8R
Height (in mm) :	66
Shape :	1.5 Bellows
Contact lip diameter :	103 mm
inner barrel diameter :	Male G3/8"
Number of bellows :	1.5 Bellows
Horizontal force :	360 N
Vertical force :	180 N
Arrow :	25 mm

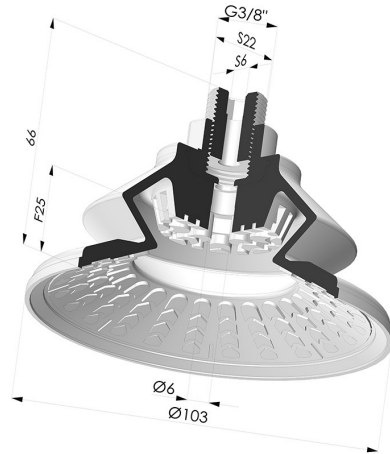

Variants:



Variant reference:

8R 102NI M38

- Color: Black
- Matter: Nitrile
- Shore Hardness: SH70