

**TECHNICAL INFORMATION**

<b>Range :</b>	Suction cup
<b>Category :</b>	Oblong
<b>Series :</b>	4RP
<b>Height (in mm) :</b>	30
<b>Shape :</b>	Oblong
<b>Length :</b>	50mm
<b>Width :</b>	16mm
<b>inner barrel diameter :</b>	Male G1/8"
<b>Number of bellows :</b>	0.5 Bellows
<b>Horizontal force :</b>	40N
<b>Vertical force :</b>	20N
<b>Arrow :</b>	3mm

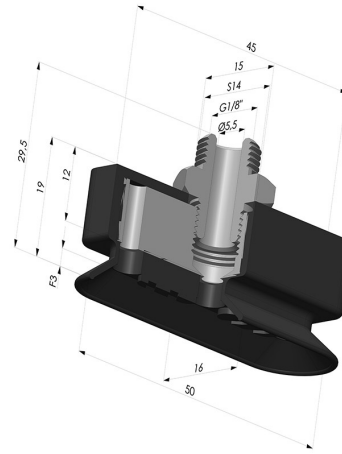

**Variants:**



Variant reference:

**4RP 52NI M18**

- Matter: Nitrile
- Shore Hardness: SH70