

TECHNICAL INFORMATION

- Range :** Suction cup
Category : With bellows
Series : 1
Height (in mm) : 16
Shape : 1.5 Bellows
Contact lip diameter : 14 mm
inner barrel diameter : 3.8 mm
Number of bellows : 1.5 Bellows
Horizontal force : 6 N
Vertical force : 3 N
Volume : 0.42 cm³
Mass : 1 g
Arrow : 5.5 mm

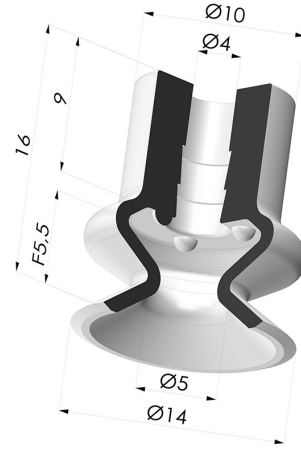

Variants:



Variant reference:
1 14MNT A

- Color: Bordeaux
- Matter: Non-staining material
- Shore Hardness: SH60



Variant reference:
1 14PU A

- Color: Blue
- Matter: Polyurethane
- Shore Hardness: SH60



Variant reference:
1 14SL A

- Color: Red food-grade CE certification
- Matter: Silicone
- Shore Hardness: SH60



Variant reference:
1 14SLT A

- Color: Translucent
- CE food certified
- Matter: Silicone
- Shore Hardness: SH60



Variant reference:
1 14NI A

- Color: Black
- Matter: Nitrile
- Shore Hardness: SH50



Variant reference:
1 14NR A

- Color: Gray
- Matter: Natural rubber
- Shore Hardness: SH60



Variant reference:
1 14SLDB A

- Color: Blue
- Matter: Detectable silicone
- Shore Hardness: SH40

Material guide:

	Material	Code	Temperature resistance (°C)	Flexibility	Abrasion resistance	UV/Weather resistance	Oil resistance	Food compatibility	Migration test
	Non-staining material Bordeaux (Shore SH60)	MNT	-20/+160	✓	✓	✓✓✓	✓✓✓	✗	✗
	Polyurethane Blue (Shore SH60)	PU	-20/+80	✓	✓✓✓	✓✓	✓✓	✗	✗
	Silicone Red food-grade CE certification (Shore SH60)	SL	-60/+250	✓✓✓	✗	✓✓✓	✗	FDA **	A, B, D2
	Silicone Translucent (Shore SH60)	SL T	-60/+250	✓✓✓	✓	✓✓✓	✓	FDA **	✗

	Nitrile Black (Shore SH50)	NI	-10/+80	✓	✓	✗	✓✓	✗	✗
	Detectable silicone Blue (Shore SH40)	SLDBLEU	60/+250	✓✓✓	✗	✓✓✓	✗	FDA **	✗

Requests for FDA and/or EC certificates must be made AT THE TIME OF ORDER. Any later request will incur additional charges. To meet the expectations of our industrial customers, NOVACOM offers the widest range of elastomer and thermoplastic materials. We can also develop new materials based on precise specifications, in order to solve specific applications for our customers.

✓✓✓ Excellent | ✓✓ Good | ✓ Low | ✗ Poor | ✗✗ Not recommended
 *FDA and/or EC certificate may be requested for various references at the time of order; please contact us.
 ** Food contact certification: (EC) 1935/2004 - (FDA) 21 CFR 177.2600
 *** Food contact certification: (EC) 10/2011 - (FDA) 21 CFR

Related products:

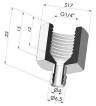

Separable Female Fitting G1/4"

Product reference: B

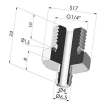

Separable Male Fitting G1/4"

Product reference: C

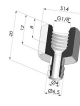

Separable Female Fitting G1/8"

Product reference: F

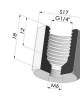

Adaptor - Female G1/4" - Female M6

Product reference: F14F6

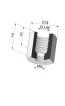

Adaptor - Female 1/8G - Female M6

Product reference: F18F6

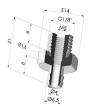

Separable Male Fitting G1/8"

Product reference: G



Adaptor - Male 1/4G - Female M6

Product reference: M14F6



Adaptor - Male 1/8G - Female M6

Product reference: M18F6



Separable Male Fitting M5

Product reference: M5C11



Separable Male Fitting M6

Product reference: M6C



Separable Male Fitting M5

Product reference: M5C

--