

**TECHNICAL INFORMATION**

**Range :** Suction cup  
**Category :** With bellows  
**Series :** 1  
**Height (in mm) :** 24.6  
**Shape :** 1.5 Bellows  
**Contact lip diameter :** 25 mm  
**inner barrel diameter :** 4 mm  
**Number of bellows :** 1.5 Bellows  
**Horizontal force :** 23 N  
**Vertical force :** 11.5 N  
**Volume :** 2.92 cm<sup>3</sup>  
**Mass :** 2.90 g  
**Arrow :** 10 mm

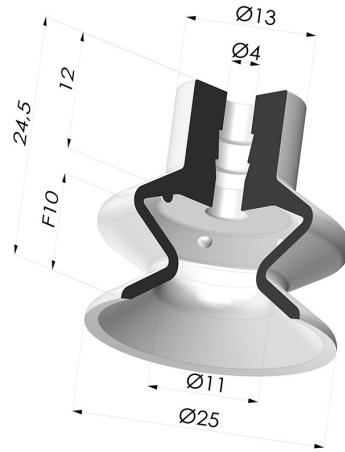

**Variants:**

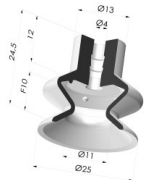

Variant reference:  
**1 26MNT A**

- Color: Bordeaux
- Matter: Non-staining material
- Shore Hardness: SH60



Variant reference:  
**1 26PU A**

- Color: Blue
- Matter: Polyurethane
- Shore Hardness: SH60



Variant reference:  
**1 26SL A**

- Color: Red food-grade CE certification
- Matter: Silicone
- Shore Hardness: SH60



Variant reference:  
**1 26SLT A**

- Color: Translucent
- CE food certified
- Matter: Silicone
- Shore Hardness: SH60



Variant reference:  
**1 26SLV A**

- Color: Green food certification CE
- Matter: Silicone
- Shore Hardness: SH40



Variant reference:  
**1 26NI A**

- Color: Black
- Matter: Nitrile
- Shore Hardness: SH50



Variant reference:  
**1 26NR A**

- Color: Gray
- Matter: Natural rubber
- Shore Hardness: SH50

**Related products:**



**Separable Female Fitting G1/4"**

Product reference: B



**Separable Male Fitting G1/4"**

Product reference: C



**Separable Female Fitting G1/8"**

Product reference: F

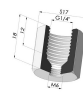

**Adaptor - Female G1/4" - Female M6**

Product reference: F14F6



**Adaptor - Female 1/8G - Female M6**

Product reference: F18F6



**Separable Male Fitting G1/8"**

Product reference: G



**Adaptor - Male 1/4G - Female M6**

Product reference: M14F6



**Adaptor - Male 1/8G - Female M6**

Product reference: M18F6



**Separable Male Fitting M5**

Product reference: M5C11



**Separable Male Fitting M6**

Product reference: M6C



**Separable Male Fitting M5**

Product reference: M5C

--