

TECHNICAL INFORMATION

Range : Suction cup
Category : With bellows
Series : 1
Height (in mm) : 27.5
Shape : 1.5 Bellows
Contact lip diameter : 42 mm
inner barrel diameter : 7.5 mm
Number of bellows : 1.5 Bellows
Horizontal force : 62 N
Vertical force : 31 N
Volume : 9.95 cm³
Mass : 10 g
Arrow : 10.5 mm

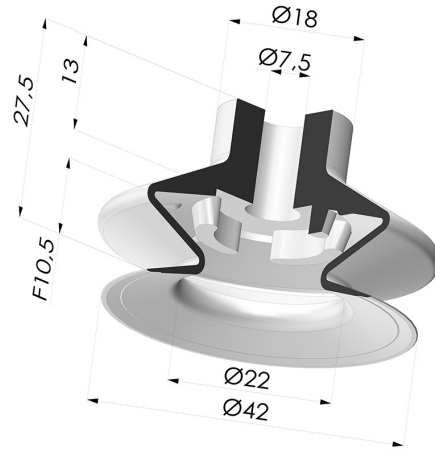

Variants:

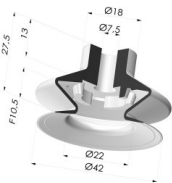

Variant reference:
1 43MNT A

- Color: Bordeaux
- Matter: Non-staining material
- Shore Hardness: SH60



Variant reference:
1 43PU A

- Color: Blue
- Matter: Polyurethane
- Shore Hardness: SH60



Variant reference:
1 43SL A

- Color: Red food-grade CE certification
- Matter: Silicone
- Shore Hardness: SH60



Variant reference:
1 43SLT A

- Color: Translucent
- CE food certified
- Matter: Silicone
- Shore Hardness: SH60



Variant reference:
1 43NI A

- Color: Black
- Matter: Nitrile
- Shore Hardness: SH50



Variant reference:
1 43NR A

- Color: Gray
- Matter: Natural rubber
- Shore Hardness: SH50

Related products:

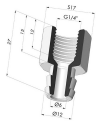

Separable Female Fitting G1/4"

Product reference: D



Separable Male Fitting G1/4"

Product reference: E

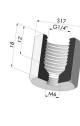

Adaptor - Female G1/4" - Female M6

Product reference: F14F6



Adaptor - Female 1/8G - Female M6

Product reference: F18F6

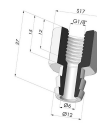

Separable Female Fitting G1/8"

Product reference: H

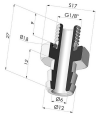

Separable Male Fitting G1/8"

Product reference: I



Crimped Female Fitting G1/4"

Product reference: L

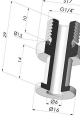

Crimped Male Fitting G1/4"

Product reference: M

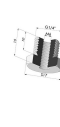

Adaptor - Male 1/4G - Female M6

Product reference: M14F6



Adaptor - Male 1/8G - Female M6

Product reference: M18F6



Screw M5 - Head Ø 14 mm - L 20.5 mm

Product reference: M5



Screw M6 - Head Ø 14 mm - L 20.5 mm

Product reference: M6



Crimped Female Fitting G1/8"

Product reference: R

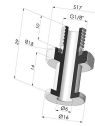

Crimped Male Fitting G1/8"

Product reference: S



Screw M8 - Head Ø 14 mm - L 20 mm

Product reference: M8T14L20.5