

**TECHNICAL INFORMATION**

- Range :** Suction cup
- Category :** With bellows
- Series :** 8
- Height (in mm) :** 39
- Shape :** 1.5 Bellows
- Contact lip diameter :** 60 mm
- inner barrel diameter :** 8mm
- Number of bellows :** 1.5 Bellows
- Horizontal force :** 128 N
- Vertical force :** 64 N
- Arrow :** 10 mm

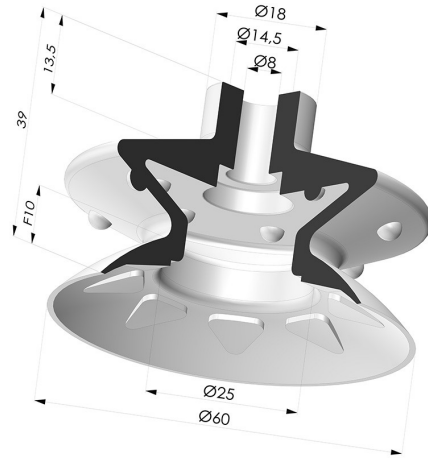

**Variants:**



Variant reference:

**82 60NI A**

- Color: Black
- Matter: Nitrile
- Shore Hardness: SH50

**Material guide:**

	Material	Code	Temperature resistance (°C)	Flexibility	Abrasion resistance	UV/Weather resistance	Oil resistance	Food compatibility	Migration test
	Nitrile Black (Shore SH50)	NI	-10/+80	✓	✓	✗	✓✓	✗	✗

✓✓✓ Excellent | ✓✓ Good | ✓ Low | ✗ Poor | ✗✗ Not recommended

\*FDA and/or EC certificate may be requested for various references at the time of order; please contact us.

\*\* Food contact certification: (EC) 1935/2004 - (FDA) 21 CFR 177.2600

\*\*\* Food contact certification: (EC) 10/2011 - (FDA) 21 CFR

Requests for FDA and/or EC certificates must be made AT THE TIME OF ORDER. Any later request will incur additional charges. To meet the expectations of our industrial customers, NOVACOM offers the widest range of elastomer and thermoplastic materials. We can also develop new materials based on precise specifications, in order to solve specific applications for our customers.

**Related products:**

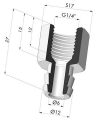

**Separable Female Fitting G1/4"**

Product reference: D

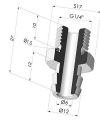

**Separable Male Fitting G1/4"**

Product reference: E

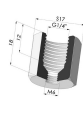

**Adaptor - Female G1/4" - Female M6**

Product reference: F14F6



**Adaptor - Female 1/8G - Female M6**

Product reference: F18F6

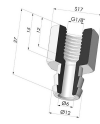

**Separable Female Fitting G1/8"**

Product reference: H

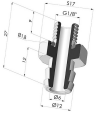

**Separable Male Fitting G1/8"**

Product reference: I



**Crimped Female Fitting G1/4"**

Product reference: L

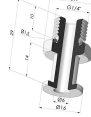

**Crimped Male Fitting G1/4"**

Product reference: M



**Adaptor - Male 1/4G - Female M6**

Product reference: M14F6



**Adaptor - Male 1/8G - Female M6**

Product reference: M18F6



**Screw M5 - Head Ø 14 mm - L 20.5 mm**

Product reference: M5



**Screw M6 - Head Ø 14 mm - L 20.5 mm**

Product reference: M6

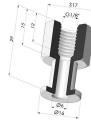

**Crimped Female Fitting G1/8"**

Product reference: R



**Crimped Male Fitting G1/8"**

Product reference: S



**Screw M8 - Head Ø 14 mm - L 20 mm**

Product reference: M8T14L20.5