

**TECHNICAL INFORMATION**

- Range :** Suction cup  
**Category :** Plates  
**Series :** 90  
**Height (in mm) :** 10  
**Shape :** Plate  
**Contact lip diameter :** 32  
**inner barrel diameter :** 5  
**Number of bellows :** 0.5 Bellows  
**Horizontal force :** 33 N  
**Vertical force :** 17 N  
**Arrow :** 2 mm

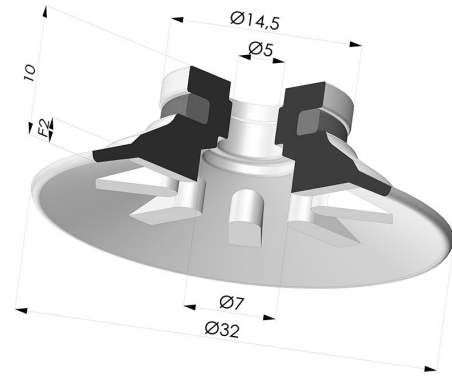

**Variants:**



Variant reference:

**90 30PU A**

- Color: Blue
- Matter: Polyurethane
- Shore Hardness: SH60



Variant reference:

**90 30SL A**

- Color: Red food-grade CE certification
- Matter: Silicone
- Shore Hardness: SH60



Variant reference:

**90 30SLT A**

- Color: Translucent
- CE food certified
- Matter: Silicone
- Shore Hardness: SH60



Variant reference:

**90 30TPU A**

- Color: Translucent
- Matter: Thermoplastic
- Shore Hardness: SH60



Variant reference:

**90 30NI A**

- Color: Black
- Matter: Nitrile
- Shore Hardness: SH50

