

**TECHNICAL INFORMATION**

- Range :** Suction cup  
**Category :** With bellows  
**Series :** 91  
**Height (in mm) :** 27  
**Shape :** 1.5 Bellows  
**Contact lip diameter :** 40 mm  
**inner barrel diameter :** 6.5  
**Number of bellows :** 1.5 Bellows  
**Horizontal force :** 57 N  
**Vertical force :** 28.5 N  
**Arrow :** 12 mm

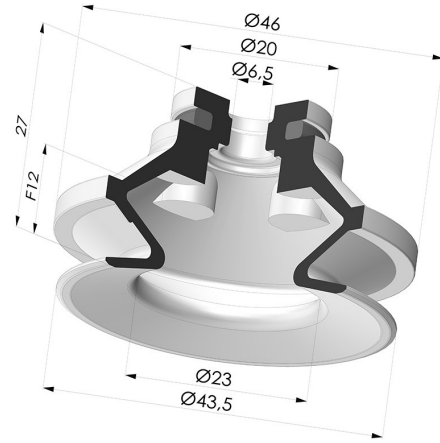

**Variants:**



Variant reference:

**91 40NI A**

- Color: Black
- Matter: Nitrile
- Shore Hardness: SH50



Variant reference:

**91 40NR A**

- Color: Gray
- Matter: Natural rubber
- Shore Hardness: SH50



Variant reference:

**91 40SL A**

- Color: Red food-grade CE certification
- Matter: Silicone
- Shore Hardness: SH60



Variant reference:

**91 40SLT A**

- Color: Translucent
- CE food certified
- Matter: Silicone
- Shore Hardness: SH60



Variant reference:

**91 40MNT A**

- Color: Bordeaux
- Matter: Non-staining material
- Shore Hardness: SH60



Variant reference:

**91 40TPU A**

- Color: Translucent
- Matter: Thermoplastic
- Shore Hardness: SH70

**Related products:**

**Bellows Suction  
Cup 1.5 folds Series  
91, Ø 40 mm**  
Product reference: 91  
40-- 18

**Bellows Suction  
Cup 1.5 folds Series  
91, Ø 40 mm**  
Product reference: 91  
40-- 14D-2

**Bellows Suction  
Cup 1.5 folds Series  
91, Ø 40 mm**  
Product reference: 91  
40-- 14D-2-F

**Bellows Suction  
Cup 1.5 folds Series  
91, Ø 40 mm**  
Product reference: 91  
40-- 14D-2-GIC

**Bellows Suction  
Cup 1.5 folds Series  
91, Ø 40 mm**  
Product reference: 91  
40-- 18D-2

**Bellows Suction  
Cup 1.5 folds Series  
91, Ø 40 mm**  
Product reference: 91  
40-- 18D-2-F

**Bellows Suction  
Cup 1.5 folds Series  
91, Ø 40 mm**  
Product reference: 91  
40-- 18D-2-GIC

**Bellows Suction  
Cup 1.5 folds Series  
91, Ø 40 mm**  
Product reference: 91  
40-- 18D-3-BD

**Bellows Suction  
Cup 1.5 folds Series  
91, Ø 40 mm**  
Product reference: 91  
40-- 38D-2

**Bellows Suction  
Cup 1.5 folds Series  
91, Ø 40 mm**  
Product reference: 91  
40-- 38D-2-F

**Bellows Suction  
Cup 1.5 folds Series  
91, Ø 40 mm**  
Product reference: 91  
40-- 38D-2-GIC