

**TECHNICAL INFORMATION**

- Range :** Suction cup  
**Category :** Plates  
**Series :** PFTF  
**Height (in mm) :** 55  
**Shape :** Plate  
**Contact lip diameter :** 116.5 mm  
**inner barrel diameter :** Female G1/2"  
**Number of bellows :** 0.5 Bellows  
**Outer diameter :** 116.5 mm  
**Horizontal force :** 484 N  
**Vertical force :** 242 N  
**Arrow :** 6.5 mm

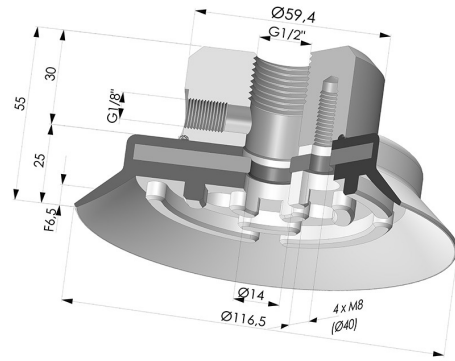

**Variants:**

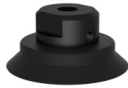

Variant reference:

**PFTF 120NI 1/2**

- Color: Black
- Matter: Nitrile
- Shore Hardness: SH50





Variant reference:

**PFTF 120SLT 1/2**

- Color: Translucent
- CE food certified
- Matter: Silicone
- Shore Hardness: SH60

**Material guide:**

	Material	Code	Temperature resistance (°C)	Flexibility	Abrasion resistance	UV/Weather resistance	Oil resistance	Food compatibility	Migration test
	Nitrile Black (Shore SH50)	NI	-10/+80	✓	✓	✗	✓✓	✗	✗
	Silicone Translucent (Shore SH60)	SL T	-60/+250	✓✓✓	✓	✓✓✓	✓	FDA  **	✗

Requests for FDA and/or EC certificates must be made AT THE TIME OF ORDER. Any later request will incur additional charges. To meet the expectations of our industrial customers, NOVACOM offers the widest range of elastomer and thermoplastic materials. We can also develop new materials based on precise specifications, in order to solve specific applications for our customers.

 Excellent | 
  Good | 
  Low | 
  Poor | 
  Not recommended  
 \*FDA and/or EC certificate may be requested for various references at the time of order; please contact us.  
 \*\* Food contact certification: (EC) 1935/2004 - (FDA) 21 CFR 177.2600  
 \*\*\* Food contact certification: (EC) 10/2011 - (FDA) 21 CFR

**Related products:**

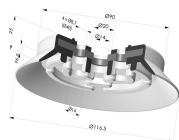

**Flat suction cup series PFG Ø 116.5 mm**

Product reference: PFG 120-- A

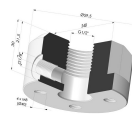

**Separable Female Fitting 1/2G**

Product reference: FTF 120 G1/2