

**TECHNICAL INFORMATION**

- Range :** Suction cup  
**Category :** Plates  
**Series :** PFTM  
**Height (in mm) :** 14.5  
**Shape :** Plate  
**Contact lip diameter :** 5.3 mm  
**inner barrel diameter :** M5  
**Number of bellows :** 0.5 Bellows  
**Horizontal force :** 1 N  
**Vertical force :** 0.5 N  
**Arrow :** 0.8 mm

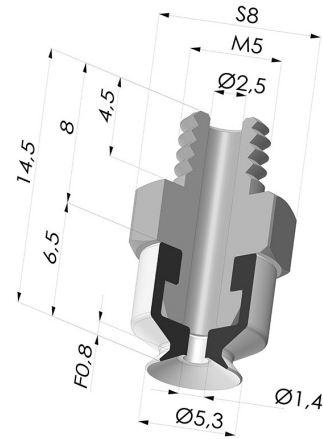

**Variants:**

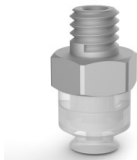

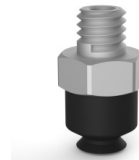

- Variant reference:  
**PFTM 5ASLT M5M**
- Color: Translucent
  - Matter: Silicone
  - Shore Hardness: SH60



- Variant reference:  
**PFTM 5ANI M5M**
- Color: Black
  - Matter: Nitrile
  - Shore Hardness: SH50

**Material guide:**

	Material	Code	Temperature resistance (°C)	Flexibility	Abrasion resistance	UV/Weather resistance	Oil resistance	Food compatibility	Migration test
	Silicone Translucent (Shore SH60)	SL T	-60/+250	✓✓✓	✓	✓✓✓	✓	FDA  **	✗
	Nitrile Black (Shore SH50)	NI	-10/+80	✓	✓	✗	✓✓	✗	✗

✓✓✓ Excellent | ✓✓ Good | ✓ Low | ✗ Poor | ✗✗ Not recommended

\*FDA and/or EC certificate may be requested for various references at the time of order; please contact us.

\*\* Food contact certification: (EC) 1935/2004 - (FDA) 21 CFR 177.2600

\*\*\* Food contact certification: (EC) 10/2011 - (FDA) 21 CFR

Requests for FDA and/or EC certificates must be made AT THE TIME OF ORDER. Any later request will incur additional charges. To meet the expectations of our industrial customers, NOVACOM offers the widest range of elastomer and thermoplastic materials. We can also develop new materials based on precise specifications, in order to solve specific applications for our customers.

**Related products:**

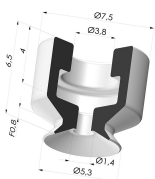

**Flat suction cup series PFG Ø 5.3 mm**

Product reference: PFG 05A-- A



**Separable Male Fitting M5**

Product reference: FTM 5A M5