

TECHNICAL INFORMATION

- Range :** Suction cup
Category : With bellows
Series : PJG
Height (in mm) : 20.2
Shape : 1.5 Bellows
Contact lip diameter : 50.5 mm
inner barrel diameter : 8 mm
Number of bellows : 1.5 Bellows
Horizontal force : 89 N
Vertical force : 44.5 N
Arrow : 5 mm

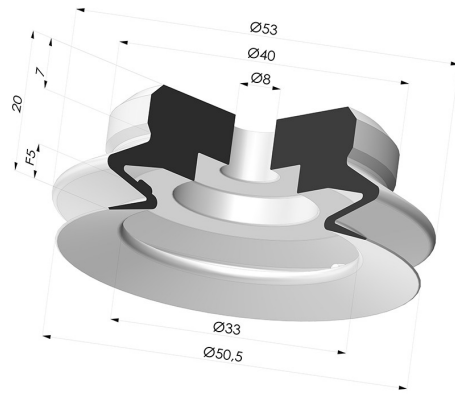

Variants:



Variant reference:

PJG 50SLT A

- Color: Translucent
- CE food certified
- Matter: Silicone
- Shore Hardness: SH60

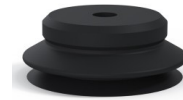



Variant reference:

PJG 50NI A

- Color: Black
- Matter: Nitrile
- Shore Hardness: SH50

Material guide:

	Material	Code	Temperature resistance (°C)	Flexibility	Abrasion resistance	UV/Weather resistance	Oil resistance	Food compatibility	Migration test
	Silicone Translucent (Shore SH60)	SL T	-60/+250	✓✓✓	✓	✓✓✓	✓	FDA  **	✗
	Nitrile Black (Shore SH50)	NI	-10/+80	✓	✓	✗	✓✓	✗	✗

Requests for FDA and/or EC certificates must be made AT THE TIME OF ORDER. Any later request will incur additional charges. To meet the expectations of our industrial customers, NOVACOM offers the widest range of elastomer and thermoplastic materials. We can also develop new materials based on precise specifications, in order to solve specific applications for our customers.



Excellent |



Good |



Low |



Poor |



Not recommended

*FDA and/or EC certificate may be requested for various references at the time of order; please contact us.

** Food contact certification: (EC) 1935/2004 - (FDA) 21 CFR 177.2600

*** Food contact certification: (EC) 10/2011 - (FDA) 21 CFR

Related products:



Adaptor - Female 1/4G - Female M6

Product reference: ADA
G1/4F M6F



Adaptor - Male 1/4G - Female M6

Product reference: ADA
G1/4M M6F



Adaptor - Female 1/8G - Female M6

Product reference: ADA
G1/8F M6F



Adaptor - Male 1/8G - Female M6

Product reference: ADA
G1/8M M6F

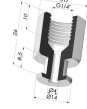

Separable Female Fitting 1/4G

Product reference: FTF
50 G1/4

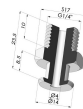

Separable Male Fitting 1/4G

Product reference: FTM
50 G1/4



Separable Male Fitting 1/8G

Product reference: FTM
50 G1/8



Screw M6 - Head Ø 11 mm - L 17 mm

Product reference: SCR
20B M6M

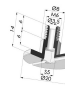

Screw M6 - Head Ø 20 mm - L 14 mm

Product reference: SCR
50 M6M



Separable Female Fitting 1/8G

Product reference: FTF
50 G1/8