

**TECHNICAL INFORMATION**

- Range :** Suction cup  
**Category :** Plates  
**Series :** 9  
**Height (in mm) :** 32  
**Shape :** Plate  
**Contact lip diameter :** 51 mm  
**inner barrel diameter :** Male G1/4"  
**Number of bellows :** 0.5 Bellows  
**Horizontal force :** 88 N  
**Vertical force :** 44 N  
**Arrow :** 6 mm

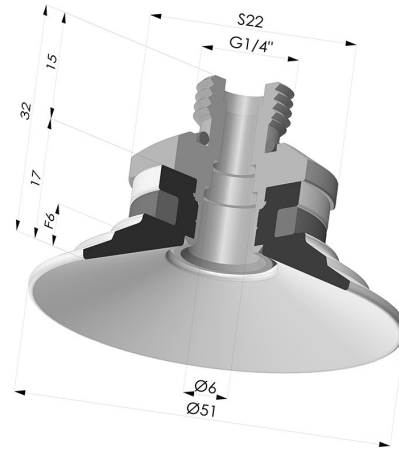

**Variants:**



Variant reference:  
**9 50SL 14D-2**

- Color: Red food-grade CE certification
- Matter: Silicone
- Shore Hardness: SH60



Variant reference:  
**9 50SLT 14D-2**





- Color: Translucent
- CE food certified
- Matter: Silicone
- Shore Hardness: SH60



Variant reference:  
**9 50NI 14D-2**

- Color: Black
- Matter: Nitrile
- Shore Hardness: SH50

**Material guide:**

|   | Material  | Code | Temperature resistance (°C) | Flexibility | Abrasion resistance | UV/Weather resistance | Oil resistance | Food compatibility  | Migration test |
|---|---|------|-----------------------------|-------------|---------------------|-----------------------|----------------|---|----------------|
|  | Silicone Red food-grade CE certification (Shore SH60) | SL   | -60/+250                    | ✓✓✓         | ✗                   | ✓✓✓                   | ✗              | FDA <br>** | A, B, D2       |
|  | Silicone Translucent (Shore SH60)                     | SL T | -60/+250                    | ✓✓✓         | ✓                   | ✓✓✓                   | ✓              | FDA <br>** | ✗              |
|  | Nitrile Black (Shore SH50)                            | NI   | -10/+80                     | ✓           | ✓                   | ✗                     | ✓✓             | ✗   | ✗              |

Requests for FDA and/or EC certificates must be made AT THE TIME OF ORDER. Any later request will incur additional charges. To meet the expectations of our industrial customers, NOVACOM offers the widest range of elastomer and thermoplastic materials. We can also develop new materials based on precise specifications, in order to solve specific applications for our customers.

 Excellent | 
  Good | 
  Low | 
  Poor | 
  Not recommended  
 \*FDA and/or EC certificate may be requested for various references at the time of order; please contact us.  
 \*\* Food contact certification: (EC) 1935/2004 - (FDA) 21 CFR 177.2600  
 \*\*\* Food contact certification: (EC) 10/2011 - (FDA) 21 CFR

**Related products:**

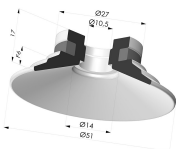

**Flat Suction Cup Series 9, Ø 50 mm**

Product reference: 9 50-- A



**Separable Male Fitting 1/4G**

Product reference: 9G14-2