

TECHNICAL INFORMATION

- Range :** Suction cup
Category : Plates
Series : 9
Height (in mm) : 26
Shape : Plate
Contact lip diameter : 51 mm
inner barrel diameter : Female G1/8"
Number of bellows : 0.5 Bellows
Horizontal force : 88 N
Vertical force : 44 N
Arrow : 6 mm

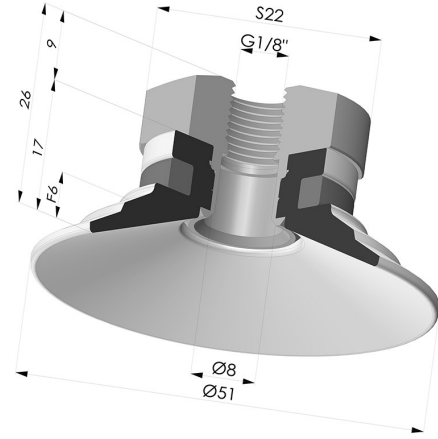

Variants:



Variant reference:
9 50SL 18D-2

- Color: Red food-grade CE certification
 - Matter: Silicone
 - Shore Hardness: SH60



Variant reference:
9 50SLT 18D-2

- Color: Translucent
 - CE food certified
 - Matter: Silicone
- Shore Hardness: SH60



Variant reference:
9 50NI 18D-2

- Color: Black
 - Matter: Nitrile
- Shore Hardness: SH50

Related products:

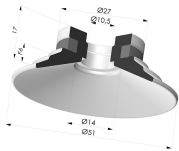

Flat Suction Cup Series 9, Ø 50 mm

Product reference: 9 50-- A

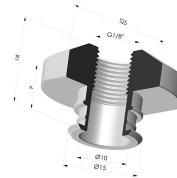

Separable Female Fitting 1/8G

Product reference: 9G18-2