

**TECHNICAL INFORMATION**

- Range :** Suction cup  
**Category :** Plates  
**Series :** 90  
**Height (in mm) :** 14  
**Shape :** Plate  
**Contact lip diameter :** 22  
**inner barrel diameter :** M5  
**Number of bellows :** 0.5 Bellows  
**Horizontal force :** 16 N  
**Vertical force :** 8 N  
**Arrow :** 1 mm

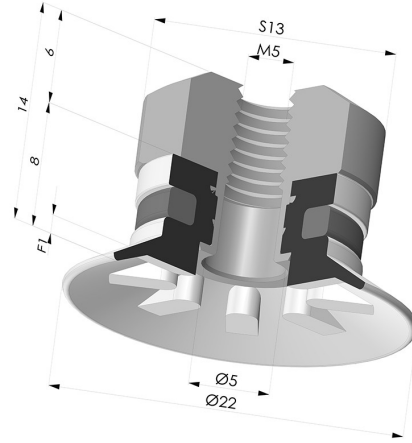

**Variants:**



Variant reference:  
**90 20SL FM5**

- Color: Red food-grade CE certification
  - Matter: Silicone
  - Shore Hardness: SH60



Variant reference:  
**90 20SLT FM5**

- Color: Translucent
  - CE food certified
  - Matter: Silicone
- Shore Hardness: SH60



Variant reference:  
**90 20NI FM5**

- Color: Black
  - Matter: Nitrile
- Shore Hardness: SH50

**Related products:**

**Flat Suction Cup Series 90, Ø 20 mm**  
 Product reference: 90 20-- A

**Separable Female Fitting M5**  
 Product reference: 9PM5-2